

2SB1398

Silicon PNP epitaxial planer type

For low-frequency output amplification

■ Features

- Low collector to emitter saturation voltage $V_{CE(sat)}$.
- Large collector current I_C .
- Allowing supply with the radial taping.

■ Absolute Maximum Ratings (Ta=25°C)

Parameter	Symbol	Ratings	Unit
Collector to base voltage	V_{CBO}	-30	V
Collector to emitter voltage	V_{CEO}	-25	V
Emitter to base voltage	V_{EBO}	-7	V
Peak collector current	I_{CP}	-8	A
Collector current	I_C	-5	A
Collector power dissipation	P_C^*	1	W
Junction temperature	T_j	150	°C
Storage temperature	T_{stg}	-55 ~ +150	°C

* Printed circuit board: Copper foil area of 1cm² or more, and the board thickness of 1.7mm for the collector portion

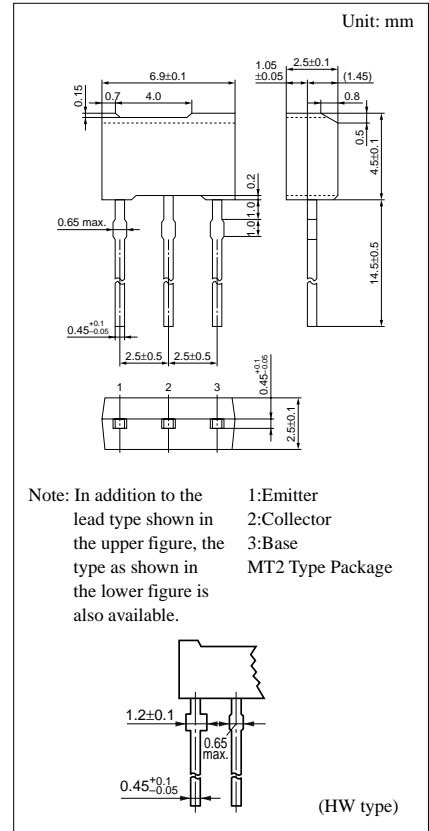

■ Electrical Characteristics (Ta=25°C)

Parameter	Symbol	Conditions	min	typ	max	Unit
Collector cutoff current	I_{CBO}	$V_{CB} = -10V, I_E = 0$			-100	nA
Emitter cutoff current	I_{EBO}	$V_{EB} = -5V, I_C = 0$			-100	nA
Collector to emitter voltage	V_{CEO}	$I_C = -1mA, I_B = 0$	-25			V
Emitter to base voltage	V_{EBO}	$I_E = -10\mu A, I_C = 0$	-7			V
Forward current transfer ratio	h_{FE}^{*1}	$V_{CE} = -2V, I_C = -2A^{*2}$	90		205	
Collector to emitter saturation voltage	$V_{CE(sat)}$	$I_C = -3A, I_B = -0.1A^{*2}$			-1	V
Transition frequency	f_T	$V_{CB} = -6V, I_E = 50mA, f = 200MHz$		120		MHz
Collector output capacitance	C_{ob}	$V_{CB} = -20V, I_E = 0, f = 1MHz$			85	pF

*² Pulse measurement

*¹ h_{FE} Rank classification

Rank	P	Q
h_{FE}	90 ~ 135	120 ~ 205

$P_C - T_a$

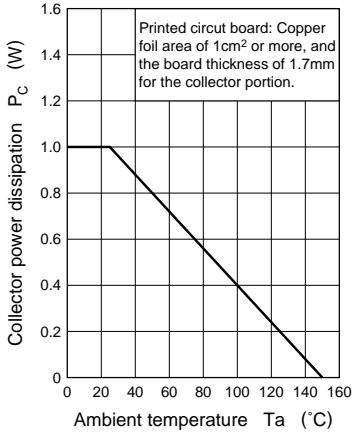

$I_C - V_{CE}$

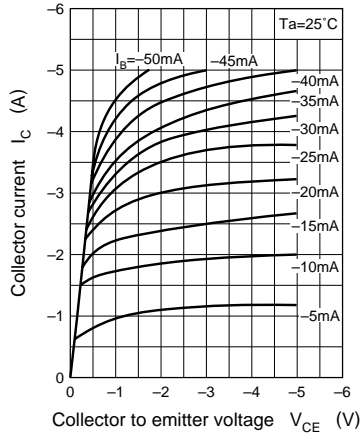

$I_C - V_{BE}$

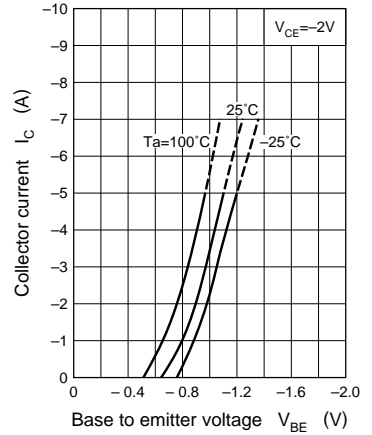

$h_{FE} - I_C$

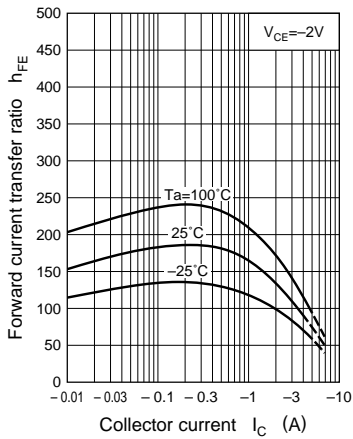

$V_{CE(sat)} - I_C$

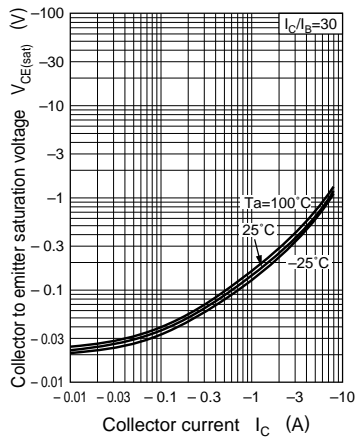

$f_T - I_E$

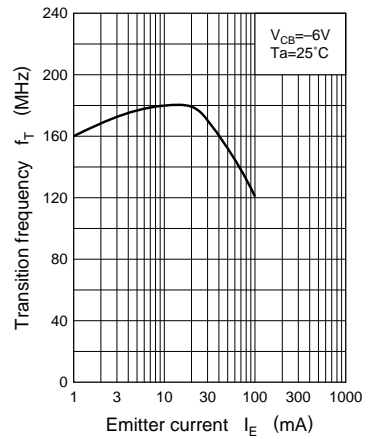

$C_{ob} - V_{CB}$

